



The future of fire detection.
Today already.

SecuriFire

Complete system family: Perfect for every application



Commercial buildings/offices

When you're responsible for the safety of a large commercial building or even an entire business park, you want to have a comprehensive overview of the situation at all times. SecuriFire permits the networking of many detectors over a wide area, while still offering a high level of redundancy and functionality.



Shopping malls

With a wide variety of tenants and a constant flow of visitors, malls require fire detection control panels to be distributed throughout the building – but also require independent control, detection and alerting. SecuriFire allows a “systems within a system” configuration, and also meets the growing demand for voice alarms with easy interfacing to those from our sister company g+m.



Hotels

Siren or voice output devices integrated in the detectors allow cost-effective alerting inside the hotel rooms themselves. SecuriFire thus offers the ideal interface for organisational fire protection and helps relieve the workload of the emergency services thanks to rapid evacuation.



Hospitals

Fire alarm system testing and maintenance is always a challenge in hospitals, where nothing can be allowed to disrupt the life-saving work. SecuriFire has a unique feature for preventing the unintentional activation of outputs. This means you can carry out maintenance, tests and program changes without disrupting the hospital's activities.



Industry

In dusty industrial environments, fire detection is never as simple as in a clean office building. SecuriFire's enhanced compatibilities in accordance with EN 54-29 make it an ideal, robust system for industrial applications. It features multiple options for adjusting the sensitivity of our detectors, and its data point analysis capability perfects the diagnosis of detector contamination to flag faults and reduce false alarms.



Data centres

A state-of-the-art data centre's availability must be well over 99.9% around the clock. These special requirements are reflected in the fire alarm system. Thanks to integrated redundancies and highly sensitive aspirating smoke detectors, Securiton's solutions provide reliable safety in highly critical applications.

System overview: The right variant for every need

The benefits to you

- Virtually unlimited applications for small self-contained to large decentralised objects
- Quick, easily understood responses thanks to intuitive operation of the integrated or remote SecuriFire MIC operating panel – at the fire alarm control panel or distributed at strategic points around the building
- Highest safety standards
- Tested and approved according to numerous EN 54 standards, including EN 54-13, EN-12094-1, DIN, VDE and many more.



SecuriFire 3000 The redundant modular fire alarm system for the most exacting requirements

- 100% redundant design: hardware and software – identical recovery system in hot standby mode
- Modular decentralised architecture
- Highly flexible system design
- Can be expanded and modified as required
- Up to 16 addressable loops allowing up to 4000 addressable devices per control panel
- Controls multi-zone extinguishing systems of all types

SecuriFire 3000's flexible, modular character makes it virtually indispensable for the reliable protection of highly decentralised building structures. Virtually any modern extinguishing system can be connected to it. As a result – and due to its maximum availability – the system satisfies the most exacting requirements for specialised applications. It is also ideal as a hub for communicating with peripheral systems.

B8-SCP3050
Basic version with built-in operating panel, protocol printer and cut-out for MMI device

B8-SCP3040
Basic version with built-in operating panel, protocol printer and cut-out for EPI device

B8-SCP3030
Basic version with built-in operating panel and protocol printer

B8-SCP3020
Basic version with built-in operating panel

B8-SCP3010
Basic version

B8-ST5
Basic version for installation in a 19" floor cabinet



SecuriFire 2000 Compact fire alarm system for medium to large objects

- Up to four addressable loops allowing a maximum of 756 devices per control panel
- Decentralised architecture
- Controls single-zone extinguishing systems of all types
- 100% software redundancy

The SecuriFire 2000 fire alarm system is ideally suited for use in large buildings. It reliably monitors large hotels, office buildings, hospitals, nursing homes, large shopping and leisure centres as well as a host of other such facilities and businesses.

B9-SCP2050
Basic version with built-in operating panel and cut-out for EPI device or single-zone extinguishing indicator

B9-SCP2040
Basic version with built-in operating panel, protocol printer and cut-out for EPI device or single-area extinguishing indicator

B9-SCP2030
Basic version with built-in operating panel and protocol printer

B9-SCP2020
Basic version with built-in operating panel

B9-SCP2010
Basic version



B9-SCP1020
with built-in operating panel

SecuriFire 1000 High-tech fire protection for smaller objects

- Cost-optimised compact fire alarm system with one addressable loop up to 3500 metres in length allowing up to 250 devices
- Sufficient space in the housing for an emergency power supply and remote alerting
- Sufficient power for addressable devices with integrated 4A PSUs

SecuriFire 1000 is ideally suited for use in small and mid-sized hotels, restaurants, guest houses, shopping and leisure centres, nursing homes as well as many other such facilities and businesses.



B10-SCP520

SecuriFire 500 For smaller businesses and unoccupied objects

- One addressable loop up to 3500-metres in length allowing up to 250 devices
- Simple configuration and programming
- Rapid commissioning
- Cost-optimised compact standalone solution with integrated indication and control map

This smallest product in the range is designed for small hotels, restaurants, guest-houses, shopping and leisure centres, nursing homes and many other such smaller facilities. The SecuriFire 500 also promises reassuring round-the-clock safety in private objects.

In comparison: The four SecuriFire models



Product comparison

	SecuriFire 3000	SecuriFire 2000	SecuriFire 1000	SecuriFire 500
19" rack version	■			
SecuriLan	■	■		
SecuriWan normative	■	■		
SecuriWan informative	■	■	■	■
Alarm loops (250 addressable devices)	up to 16	up to 4	1	1
Certified for extinguishing according to EN 12094	■	■		
Power/output current	280W/7A	160W/4A	160W/4A	90W/2.5A
MMI bus 16 devices @ 1200 m Fire brigade maps/operat- ing panels/ intervention panels	■	■	■	
EPI bus 3 addressable devices @ 1 m Fire brigade maps/printer/ intervention panels	■	■	■	■

SecuriFire highlights

Up to 6 million m² of monitored surface in total

SecuriWan allows the networking of up to 100,000 fire detectors spread across more than 4000 decentralised fire alarm control panels. Their total monitoring area corresponds roughly to the land surface of Gibraltar.

3500 m maximum addressable loop length

SecuriLine eXtended links up to 250 addressable devices. This facilitates extremely flexible and cost-saving planning, including for large objects.

1 + 1 = 3 50 years

Maximum availability is guaranteed: the SecuriFire 3000 fire alarm control panel has 100% redundant hardware and software system structures. Even in the event of a fault, all functions such as detectors, alerting, plain text display, actuation of fire incident controls, etc. continue to perform without interruption.

The latest-generation SecuriStar combined fire detectors are based on more than 50 years of in-the-field experience around the world.

Control panels: Guaranteed reliability and precision

Redundancy – where failure is unknown

A fire on business premises destroys more than just property – it also puts human life at risk and can pose an existential threat to the business itself. The faster it is discovered, the lower the risk of triggering a chain of events with dire consequences. The aim is to counter the fire risk with an opponent that is as intelligent as it is strong. An opponent that is always ready – and that watches over your safety even when the situation risks getting out of hand. SecuriFire from Securiton is a fire alarm system that outperforms all previous systems in terms of intelligence and reliability. SecuriFire incorporates a sensational feature: its fully redundant system architecture offers twice the level of safety – this virtually rules out system failure. Securiton does not compromise when it comes to protecting lives and property.

Duplicated concepts are safer

All the microprocessors, components and system structures in the fire alarm control panels are duplicated. The connections between the control panels can also be duplicated and thus redundantly arranged. A second, identical system runs in hot standby mode parallel to the active operating system. An error in the active system immediately triggers an uninterrupted switchover to the second system. The fire alarm system's functions – detection, alerting, plain text display, etc. – remain seamlessly in operation. Only a system fault message shows that the second system has taken over active operation. The result: maximum reliability every day and night of the year.

Maximum quality at every level

SecuriFire's smart technology was developed and manufactured in Switzerland, Germany and Austria. As a consequence, the individual components and entire system offer the best possible quality and reliability. The intelligent system minimises false alarms and facilitates predictive maintenance – the best guarantees for stability, robustness and maximum reliability.

SecuriFire control panels – the inside story

- Device bus for the connection of external indication and control maps
- Data interfaces for devices ranging from protocol printers to building management systems
- Various basic platforms and a variety of expansion maps
- Event memory for 10,000 messages, expandable to up to 65,000
- Interface for connecting to the fire brigade or a permanently manned alarm receiving centre
- Serial interface to standards-compliant voice alarm systems
- Earthed metal housing

The benefits to you

- 100% redundant system design
- For constant availability – maximum protection of human lives and property
- Maximum reliability
- Developed and produced in Europe
- Modularity and variety of interfaces to peripheral systems for superb flexibility as well as cost and time savings in terms of planning





Networking: Built on digital intelligence

Networking without limits – with SecuriLan

SecuriLan is the main artery of the system. It connects up to 16 control panels to form a very extensive and effective fire alarm system. The individual control panels and remote operating panels can be up to 1200 metres apart. The use of optical fibre allows this to be increased to almost any distance. Although the system is decentralised, it behaves like a single fire alarm control panel. Conveniently, it is possible to poll and operate all the statuses of the devices across the entire network – right down to the individual fire detectors – from any operating panel. This saves time and money.

Security and safety are also top priorities when it comes to data transmission via SecuriLan. This is why every element of the SecuriLan is routed fully redundantly. The elements and subsystems constantly communicate with each other via a specially developed digital data protocol. Automatic test cycles and test routines operate on an ongoing basis in the background. Electromagnetic interference is filtered out in the SecuriLan, eliminating potential communication disruptions. This results in a high-security mesh that is resistant even to multiple faults.

SecuriLan – secure, redundant networking

- Up to 16 autonomous control panels
- Maximum reliability at all levels
- Secure data transmission via redundant SecuriLan
- Close-meshed diagonal networking with SpiderNet technology
- Continuous automatic system checks
- Remote system diagnosis

Versatile communication and connection to management systems

SecuriFire control panels incorporate a wide variety of interfaces and standardised protocols such as BACnet, ESPA, Modbus and VdS2465. Other protocols are available via the SecuriLink UMS Gateway – e.g. OPC-UA or OPC-DA. As a result, the control panels are compatible with many other systems such as superordinate management systems.

The wide range of interfaces and protocols allows modern third-party systems to be easily connected. Whether you want to integrate a voice alarm system or install an interface to a video fire alarm or gas warning system – we have the appropriate solution.

Central download

The “Central download” feature enables you to import planning data into the SecuriLan via a single control panel and distribute it across the entire network in just one work step.

The benefits to you

- A range of protocols offer compatibility with other systems and easy connection to superordinate management systems
- Secure data transmission via redundant SecuriLan
- Time and cost savings thanks to system-wide operation



SecuriLine eXtended

Inside the building, the fault-proof data highway connects up to 250 devices over a length of up to 3500 metres from the control panel.

SecuriLan

SecuriLan combines up to 16 autonomous control panels to form a comprehensive fail-safe fire alarm system for any building.

SecuriWan

SecuriWan connects several sites as well as different device types and technology generations with each other via IP technology.

SecuriWan – easy networking of sites

The intelligent and flexible SecuriWan IP network enables fire alarm systems at multiple locations and featuring different types and generations can be connected with each other. Because the system can be expanded or adapted almost at will, it adapts perfectly to local circumstances.

Existing networks can be used via the intranet/internet for cross-site communication – this in addition to the standards-compliant establishment of exclusive networks of fire alarm control panels. Existing SecuriLan networks can also be integrated very easily, with encrypted connections guaranteeing maximum security.

Effortless planning and a crystal-clear overview

The SecuriWan planning software integrated in SecuriFire Studio establishes the physical and logical relationships between the individual control panels. This graphical user interface is an immense help when creating a project and saves a great deal of time by providing clear visualisation of the SecuriWan network.

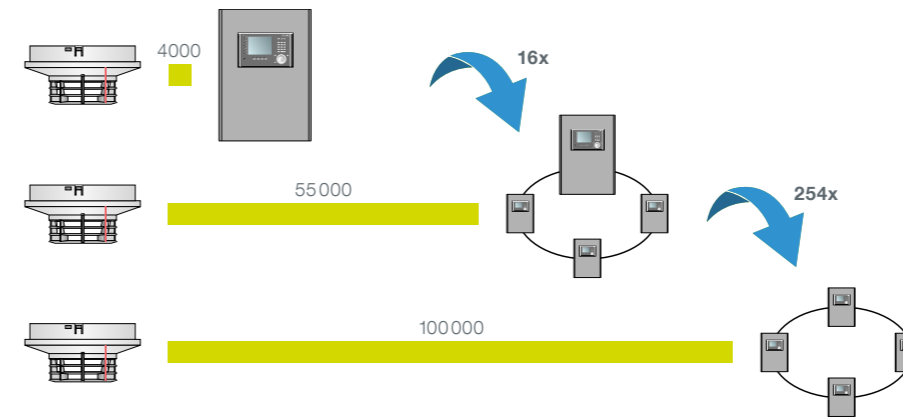

Simple expansion: SecuriLan networks up to 16 control panels and 55,000 fire detectors to form a powerful complete system; SecuriWan networks up to 254 SecuriLAN networks and up to 100,000 detectors.

The benefits to you

- Time and cost savings by means of straightforward project planning thanks to user-friendly software support
- Easy cross-site communication using an existing network (intranet/internet)
- SecuriWan enables the integration of up to 254 SecuriFire control panels and 100,000 fire detectors for maximum expansion options





Operation: Gain a head start with quick responses

Responses within seconds prevent major damage in an emergency. Securiton has designed the MIC main indication control panel in such a way as to enable users to find their way around the clearly laid-out 5.7-inch TFT colour display without wasting valuable time, even in stressful situations. The MIC comes pre-programmed with more than 20 languages – this also helps intuitively make the right decisions.

When things get serious, SecuriFire calls for help in an instant. In the event of a fire, the fire alarm system immediately sends out the appropriate messages via its alerting interfaces and alarm units. Alternatively, it informs superordinate computer systems or fire brigade management systems if it is connected to them. Once on site, the emergency services gain valuable time: the indication and control maps and layout plans show at a glance where the fire is located.

SecuriFire MIC – the smart all-rounder

- Simple, intuitive operation via the SecuriWheel
- Information overviews via the colour display and plain text
- Availability of more than 20 different languages
- Enables rapid, targeted responses from the emergency services
- Housing front labelled with icons only: situations can be grasped at a glance
- Protocol printer interface
- Extension bus for up to three additional operation and display extensions
- Available as a built-in version (control panel) and as a remote version with its own map case
- Polling of the event memory across the entire system

- Memory card slot for expanding the internal event memory to over 65,000 entries
- Identical operating philosophy for all control panel types, VirtualMIC and SecuriWan

VirtualMIC – operation and display on desktop PCs or laptops

The built-in or remote SecuriFire MIC is equivalent to SecuriFire VirtualMIC on desktop PCs or laptops. It offers the same functions, controls and displays. The connection to the fire alarm control panel is established via Ethernet. Employees can use it to monitor and operate the control panel e.g. from a reception desk – just as if they were on a SecuriFire MIC operating panel.

Email alarms – encrypted, of course

If necessary, SecuriFire sends various fault and alarm signals by email to authorised recipients. The system uses an SSL-encrypted protocol for this purpose.

SecuriFire MobileControl – the smart app for operators

Company facility managers and safety officers as well as private homeowners have their SecuriFire fire alarm systems under perfect control with MobileControl, thanks to monitoring and operation via smartphone or tablet (iOS and Android). The mobile app displays the current operating state of the safety systems in real time together with alarm and fault messages. Furthermore, in the event of alarms and faults, users automatically receive push notifications on their mobile device. This enables rapid responses to be initiated from any location, which can, among other things, minimise the risk of downtime.

Direct operation of systems via MobileControl is also possible. Georeferencing ensures that the user remains within the perimeter of the building when operating the system. This saves unnecessary steps and associated costs. In the event of false alarms, it has also proved possible to prevent the unnecessary and costly deployment of the fire brigade with just a few finger

taps. Companies operating across multiple locations will appreciate the fact that MobileControl is multi-site optimised and covers all systems. It goes without saying that access via the mobile network and interfaces is protected.

The benefits to you

- Instant response thanks to the intuitive, clear control panel – available in over 20 languages
- Displays of the current operating state and fast, location-independent responses to events thanks to the smart “SecuriFire MobileControl” app

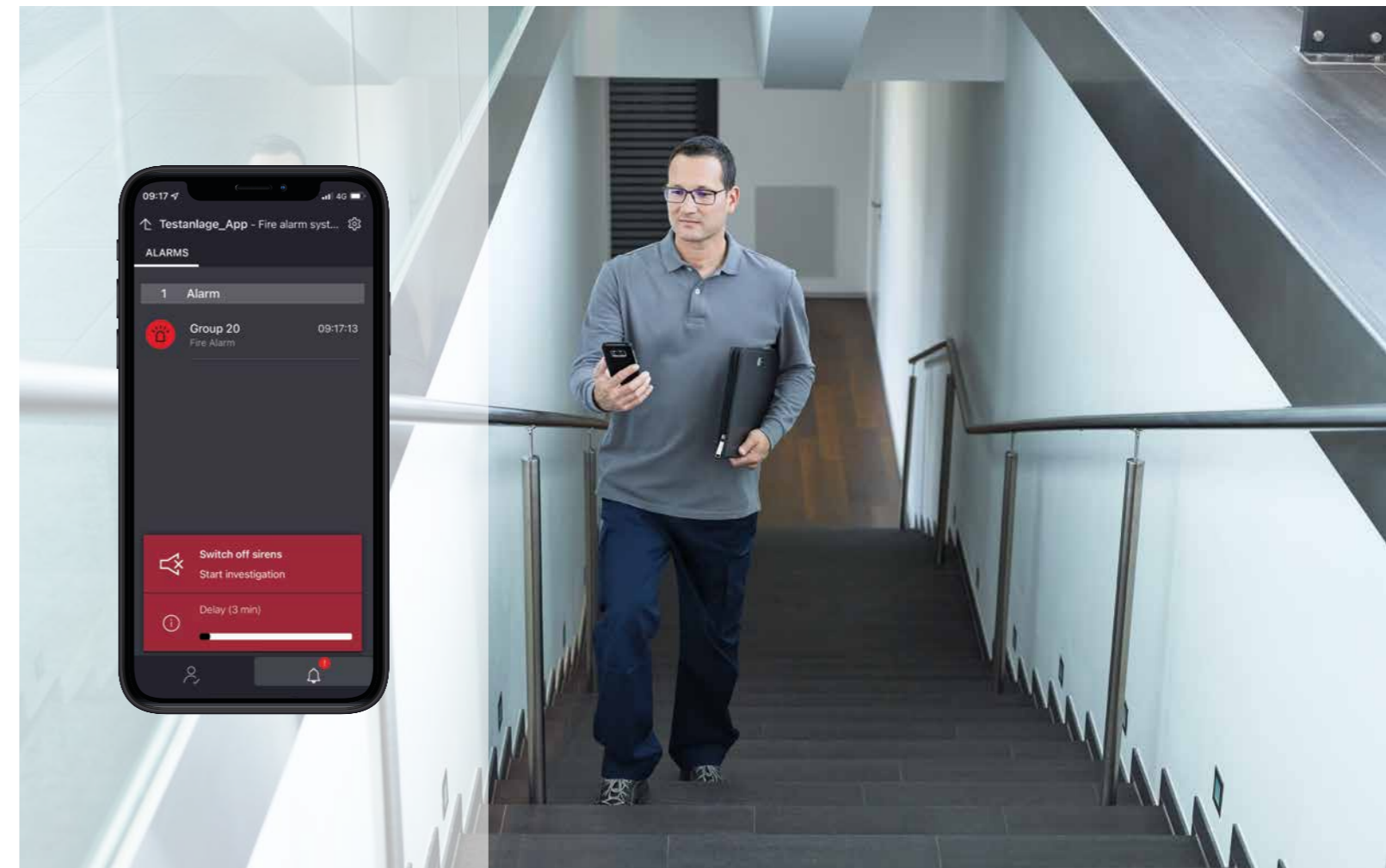

Field level: The fault-proof SecuriFire data highway

Everything on a secure footing

Powerful, reliable and scalable: SecuriLine eXtended – the addressable loop from SecuriFire. From the control panel, it runs through the building over a length of up to 3500 metres. SecuriLine eXtended serves as a data highway for up to 250 elements and a fault-proof connection to and from the control panels. Failure of a device connected to the addressable loop has no impact on the other elements. The same goes for a short-circuit or breakage of the line. If a device fails, its location is precisely located and displayed.

The devices – an unbeatable team in the fight against fire

Monitoring, detecting, alerting and controlling: these are the tasks of the devices connected to SecuriLine eXtended. They are all easy to program individually and are immune to electromagnetic interference. This eliminates possible communication faults or false alarms. The choice, locations and programming of the individual devices can be tailored precisely to your needs – no two SecuriLine eXtendeds are the same.

The detector most commonly deployed is the SecuriStar multi-sensor detector. As an intelligent all-rounder, it can be used as a smoke, temperature or combined detector, depending on the requirements and application. The reliable LKM 593X ventilation duct detector senses smoke in locations with air velocities of up to 20 m/s. Special fire detectors such as aspirating smoke detectors are integrated into the addressable loop via a SecuriLine eXtended interface. Other elements include the loop siren, loop flashing light, manual call point and various modules with relays or input and outputs. These enable the connection of further devices including wireless detectors.

Simple, flexible configuration

SecuriLine eXtended is not just for alarm signals. Detectors also send status information or self-test data to the control panel. The formation of logical detection zones is independent of their physical affiliation to a SecuriLine eXtended. For example, detectors from different addressable loops can be grouped together, which significantly reduces the amount of wiring required. Thanks to the user-friendly software, SecuriLine eXtended is very easy to design, program and put into operation – and gets you there in no time at all.

The benefits to you

- Minimal wiring needed, even in large buildings, thanks to our SecuriLine eXtended addressable loop (up to 3500 metres and 250 devices per loop)
- High availability thanks to fault-free data transmission

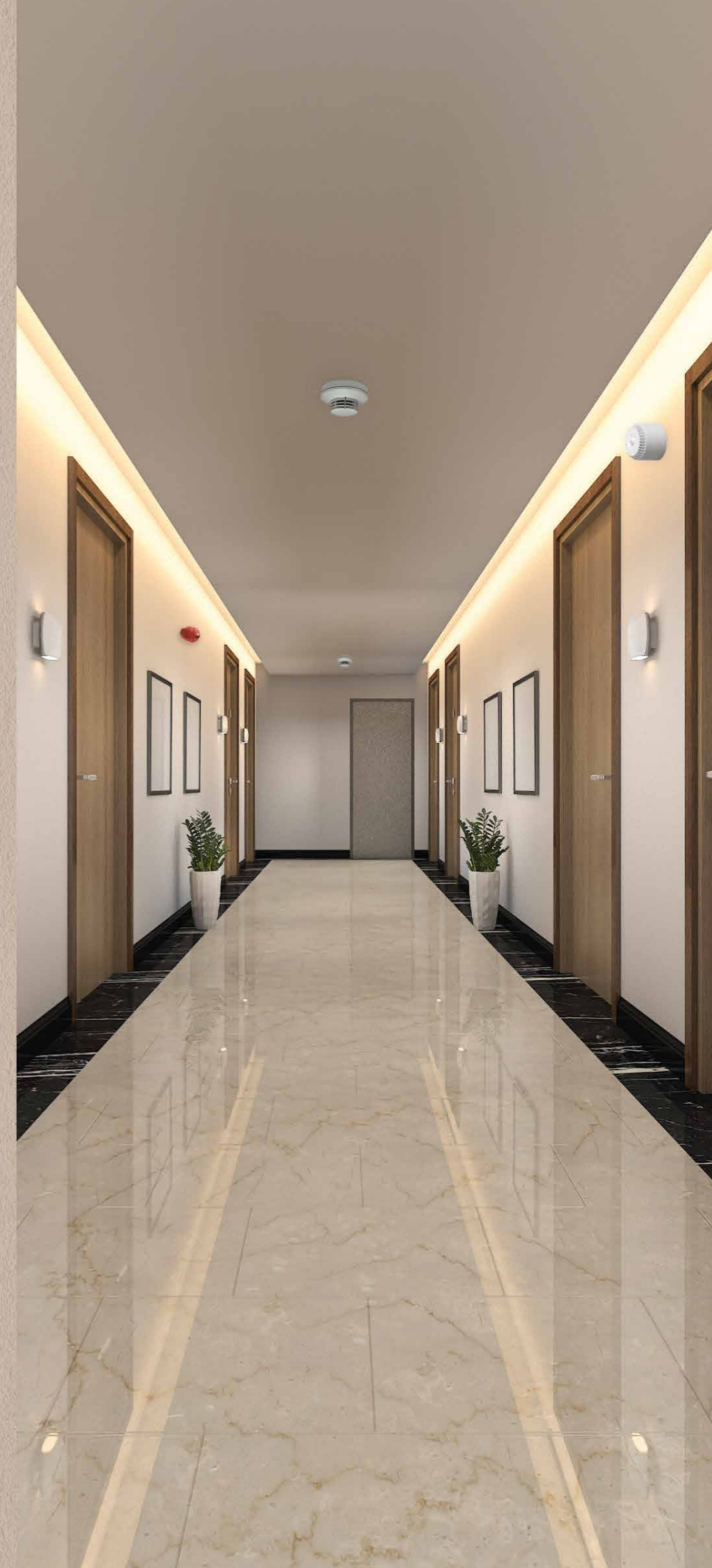

Further details of SecuriLine eXtended devices securiton.com/securline-en

Special fire detection technology



Detectors for explosive atmospheres
The MMD 130 Ex-i is an intrinsically safe smoke and heat detector based on the 'current increase' principle for early fire detection in potentially explosive zones. Together with manual call points, the components are approved for use in ATEX zones 1, 2 and 22.



Linear heat detectors
SecuriHeat ADW or LIST linear heat detectors function perfectly even under the most difficult conditions and detect fires under extreme conditions for all EN 54-22 classes. Thanks to the Config over Line function, you can carry out the configuration, commissioning and maintenance of ADW 535s at the fire alarm control panel.



Flame detector
The family of infrared flame detectors is suitable for the detection of open fires according to EN 54-10 (Class 1 + 2). Thanks to intelligent algorithms offering greater error resistance, they also reliably detect smokeless fires.



Wireless fire detectors
The SecuriAir wireless fire alarm system is used in applications where installations or extensions via wire lines are very difficult or impossible to implement for cost or aesthetic reasons, e.g. in historical buildings, museums, churches, libraries or art galleries.



Aspirating smoke detectors
SecuriSmoke ASD aspirating smoke detectors are among the most precise and reliable early warning systems. Very user-friendly, they are highly sensitive and react instantly to incipient fires for ultra early fire detection. Thanks to the Config over Line function, you can carry out the configuration, commissioning and maintenance at the fire alarm control panel.

Linear smoke detectors
SecuriBeam ILIA and BSD linear smoke detectors instantly detect smoke and flames using an infrared light beam – in accordance with EN 54-12 and even under the most difficult conditions.



Extinguishing



Sprinkler test box
The addressable module of the SPB 563 sprinkler test box is the link between the sprinkler system and the fire alarm control panel. It is used to display and transmit operating states of a wide variety of sprinkler systems and also enables efficient test operation.

Connection of extinguishing systems
SecuriFire enables effective connection of all types of extinguishing equipment with addressable limit switches for sprinkler monitoring, blocking devices, VdS extinguishing interfaces, manual triggering and stopping devices, and extinguishing control panels.



Fire detection technology

Multi-criteria fire detectors
SecuriStar MCD/CCD addressable combined detectors combine the benefits of smoke, heat and CO detection compliant with EN 54-5/-7/-26/-29/-30 in a single device. Their intelligent evaluation logic guarantees excellent response behaviour with minimum false alarms. You can optionally integrate acoustics and voice output.

Manual call points
The addressable SecuriStar MCP manual call point is used for manual alerting in fire alarm systems in accordance with EN 54-11. It offers major advantages thanks to its easy, fast installation, tamper-proof design and comprehensive range of accessories.

Ventilation duct fire detector
The addressable LKM ventilation duct detector monitors duct dimensions of up to 3 m and air velocities of up to 20 m/s in accordance with EN 54-27.

Audible alerting
Addressable sirens reliably draw attention to the danger. Their tone and volume are easy to adjust.

Optical alerting
The flash rate can be defined for the addressable flashing lights.

Input/output modules
Addressable loop modules allow the connection of a large number of conventional devices, collectively addressable detection zones and intrinsically safe circuits. Thanks to monitored inputs/outputs and programmable fail-safe states, they are also ideal for the decentralised activation of fire incident controls or extinguishers.



System detectors: Ultra reliable detection

The most sophisticated combination of smoke and temperature detection

The future of fire detection: the SecuriStar product line points the way. The latest generation of SecuriStar fire detectors detects and reports incipient fires with unprecedented reliability and precision. This is because smoke detection is combined with the precise evaluation of room temperature – as well as carbon monoxide (CO) measurement data. The unique Cubus levelling is used to automatically adapt devices' sensitivity to the ambient conditions.

SecuriStar fire detectors perform exceptionally well wherever you need effective protection for lives and property. While your installation and operation efforts are reduced to a minimum, the intelligent guards impress with maximum performance: maximum detection and false alarm protection, forward/backward compatibility and numerous additional features ensure that you can now fulfil your protection mandate even more confidently. Securiton's fire detectors also set new standards when it comes to convenience and cost-effectiveness.

Sophisticated features for straightforward operation

The new SecuriStar detectors monitor themselves continuously. Even slight soiling cannot impair their functional reliability: if soiling is detected, the detector automatically adjusts its alarm threshold. Time-consuming calibrations are no longer required. False alarms are effectively eliminated – also thanks to the switching function between day and night operation for individual detection criteria. This is particularly effective in e.g. kitchens, canteens, welding rooms and chemical laboratories. Short-circuits in the SecuriLine eXtended addressable loop are handled autonomously by the system: if necessary, when communicating with the control panel, the logic simply changes direction.

The built-in individual display indicates the alarm. It can be seen from every angle and configured so that it flashes cyclically when the detector is fully functional. In addition, an external remote display can be connected directly to the detector, mounted outside the room if necessary and also programmed independently of the detector's individual display.

The benefits of SecuriStar fire detectors

- Addressable fire detector with self-monitoring
- Instant detection of incipient fires
- The right detector for every risk profile
- One solution for all applications: cost-saving universal detector with smoke and heat sensors compliant with EN 54-5 and EN 54-7 and with combined detection methods compliant with EN 54-29
- CO detection method compliant with EN 54-26
- Cubus levelling to adapt to ambient conditions
- Continuous self-monitoring and soiling evaluation
- Simple mounting and maintenance
- Comprehensive programming functions – each detector easily and individually programmable
- Elegant design
- Integrated short-circuit isolators compliant with EN 54-17
- Integrated output for room indication lamps
- Same detector base for all SecuriStar fire detectors
- Colour customisation

Cubus levelling: automatic adaptation to ambient conditions

The SecuriStar fire detector only needs to be parameterised once. It adapts to its environment permanently and completely independently. Using the Cubus levelling system developed by Securiton, the fire detector continuously measures its ambient parameters such as temperature and carbon monoxide concentration. Based on these values, it precisely determines the optimum sensitivity for its location and sets its alarm thresholds accordingly.

The benefits to you

- Optimum detection reliability and precision protect lives and property
- Maximum reduction of false alarms thanks to self-monitoring, detector day/night switching feature, and automatic adaptation to ambient conditions
- Reduced storage and procurement costs through use of a standard detector base for all SecuriStar fire detectors



SecuriStar MCD 573X

Enhanced performance for fewer false alarms

- EN 54-5, EN 54-7 and EN 54-29 compliant
- High-precision smoke and temperature symmetries
- Optimal inflow behaviour
- Very low current consumption



SecuriStar CCD 573X

Detects dangerous carbon monoxide

- EN 54-5, EN 54-7, EN 54-26, EN 54-29 and EN 54-30 compliant
- Temperature and CO-supported smoke evaluation (Cubus + levelling)
- Technical CO alarm according to EN 50291-1 and adjustable technical CO pre-signal (20-320 ppm)
- Lowest possible false alarm rate



SecuriStar MCD 573X-S/-SP

Audible power for fast responses

- EN 54-3, EN 54-5, EN 54-7 and EN 54-29 compliant
- Integrated audible alarm – up to 92 decibels
- Automatically synchronised alarm transmitters
- Integrated voice alarm, 3 announcements in 4 languages
- Optional: uninterrupted audible alerting



SecuriStar MCP 545X N

Alerts emergency services easily, quickly and reliably

- Manual call point compliant with EN 54-11 Type A
- Integrated status and alarm indicator
- Surface-mounted and flush-mounted variants in IP24 or IP67
- Protection against misuse thanks to sealable cover

Planning, installation and commissioning: Approaching the goal step-by-step

Quick configuration – without extensive programming knowledge

SecuriFire fire alarm control panels are easy to program using an ordinary computer. The practical SecuriFire Studio programming tool needs just a few steps to guide you to the perfect solution for your custom fire detection system. With the SecuriFire 500, you can use the practical EasyConfig SecuriFire programming aid. This will take you to your goal with just a few clicks of the mouse.

Fire extinguishing assistant – helps keep a cool head

Built-in fire-extinguishing systems are quickest at stopping incipient fires in their tracks. Here, too, SecuriFire plays an important role. This is because the fire alarm system automatically activates these extinguishing systems. Fires are fought automatically upon detection – or after a programmed delay. Virtually all modern extinguishing systems can be connected to SecuriFire: CO₂ high-pressure and low-pressure extinguishing systems, inert gas and argon systems, water spray and sprinkler systems, and chemical systems such as Novec. An integrated extinguishing assistant in SecuriFire Studio helps you simply and clearly navigate the complex parameterisation of an extinguishing system.

Fire event matrix export – because overviews help

Do you want to check your fire incident control planning, or do you need clear documentation? The integrated fire event matrix generator automatically generates a matrix from your planning, which can also be exported to classic Office formats for further processing. This allows you to keep track of complex controls.

SecuriFire Scan – efficient detector assignment

The helpful SecuriFire Scan mobile application helps you with the electrical installation. Zone and detector numbers are assigned during mounting. Subsequent detector assignment in SecuriFire Studio can take place automatically. This minimises sources of error and saves valuable time with the configuration.

BIM objects – the data is ready

Securiton supports the building information modelling (BIM) process with a steadily growing library of BIM-specific data for SecuriFire products.

Config over Line – for easy, centralised configuration and maintenance

Securiton massively increases convenience and efficiency when it comes to managing its special fire detectors, SecuriSmoke ASD and SecuriHeat ADW: Securiton's world-leading Config over Line solution controls devices from the fire alarm control panel. Up to now, parameterisation, commissioning and maintenance were burdensome procedures, as technicians had to poll every single detector in a system using their laptop. This is no longer the case: thanks to remote access using Config over Line, these tasks can be carried out conveniently at the fire alarm control panel.

Communication between the detectors and the fire alarm control panel requires no additional cable installation. Data is exchanged via the existing SecuriLine eXtended addressable loop.

SecuriFire Studio – everything under control when programming

What do you need to plan, configure, program, commission and operate your SecuriFire system? A standard desktop computer or laptop. SecuriFire Studio is a true programming miracle. The tool guides you step-by-step until you have found the perfect solution for your custom fire alarm system. SecuriFire Studio's clear user interface helps you find your way in no time at all. You can design the system topology intuitively, position the control panels and SecuriLines in the building and select the right detection and other peripheral devices. This saves a lot of time. You can also perform system diagnostics, create specific texts for the display and operating panel, check network connections and configure network settings. It goes without saying that Securiton's fire detection specialists will be happy to assist you.

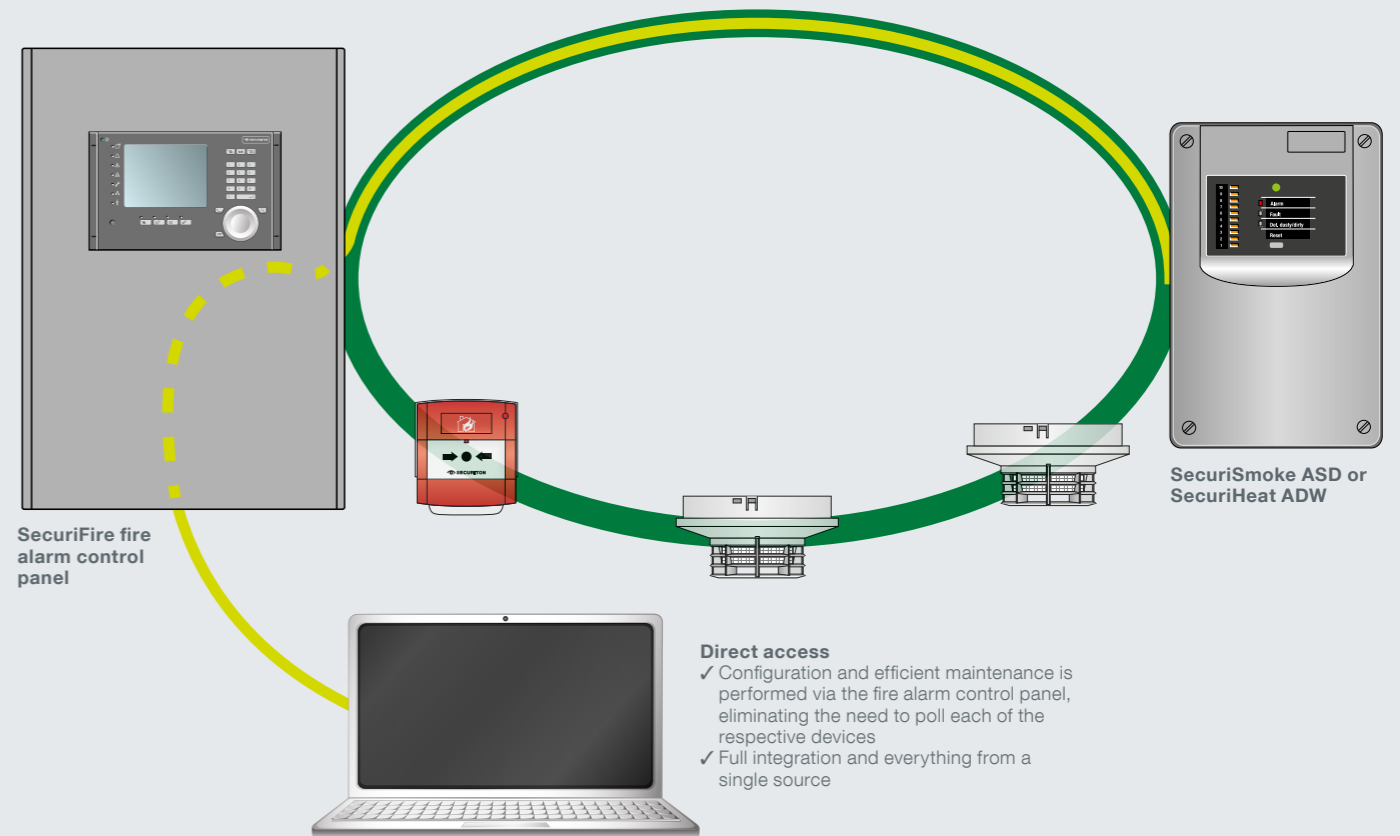

Config over Line

- Direct access**
- ✓ Configuration and efficient maintenance is performed via the fire alarm control panel, eliminating the need to poll each of the respective devices
 - ✓ Full integration and everything from a single source

Even if you are modifying or expanding your business, you can save a lot of time and money thanks to this smart programming tool: the planning data is simply imported via a service interface; the data is then distributed across the entire system via the SecuriLan. The system keeps you up to date during operation. Detailed information is provided by the event memory and protocol printer. They record all changes to the system in plain text, including alarms, faults, switching on and off, operating procedures, service instructions, etc.

The benefits to you

- Efficient, convenient and reliable configuration and maintenance of special fire detectors via SecuriLine eXtended
- Easy maintenance even in hard-to-reach locations such as high-bay warehouses, refrigerated/frozen warehouses, data centres, detention facilities and lift systems without disrupting operations
- Lower installation costs as no additional cable installation is necessary

Maintenance: Efficiency through smart tools

RemoteAccess – effective remote support

Faster responses, fewer work steps, optimised maintenance: these are the benefits offered by RemoteAccess. In the event of a fault, technicians can quickly check the current operating states and analyse the possible causes of a technical event. In many cases, the fault can be rectified without the need for a technician to travel to site: if authorised to do so, the technician programs and thoroughly tests the safety system via RemoteAccess. Remote analysis can also be used to precisely guide the on-site building services technicians, which can be just as expedient. Location-independent remote access is also useful for regular inspection and maintenance interventions. Technicians determine the exact requirements in advance and always have the right materials with them on site.

Detector stimulation – safety after data changes

After changing the software or adapting the planning, you want to be sure that the entire fire alarm system is working properly. Detector stimulation is a very effective method for this: it checks every detector connected to the loop fully automatically. It is started with a command for a complete alarm ring.

Detector stimulation checks not only that each detector's data transmission is correct, but also the measurement technology. Smoke evaluation is checked via a real signal flow – from the detector controller to the measuring sensor and back to the controller. This provides clear information on the functionality of the (bidirectional) transmission link, the optics and the multifunctional evaluation controller in the detector.

Predictive maintenance – preventive replacement eliminates false alarms

Detector status read-outs provide precise information on the detector's current state in terms of alarm and fault conditions, and on the current status of its soiling and control tracking. In doing so, the software tool also calculates the time the tracking is expected to reach its limit. Replacing the detector in good time helps avoid false alarms and faults caused by soiling.

Guided maintenance – so that nothing is forgotten

SecuriFire's "Guided maintenance" feature is the ideal tool for the end-to-end testing of a fire detector line. The alarm LED of each detector lights up until the technician acknowledges the flashing detector with test gas. This ensures that no detector is forgotten. The technician can also check the topology of the alarm loop and validate the correct software addressing.

Signature test – check while fully operational

Due to new detection algorithms in many fire alarm systems, it is practically impossible to test a detector using test gas while the system is fully operational. In many cases, detectors can only be tested in maintenance mode, which does not correspond to the normal status of a system.

SecuriStar detectors are different: while fully operational, they are quickly and efficiently transitioned to an alarm state using a defined signature test based on a test gas. The detectors immediately provide visual feedback on the measurement via the alarm LED. The signature test can be applied to both the smoke and temperature criteria. It simultaneously triggers all necessary fire incident controls, alerts and displays in the control panel.

"Secure outputs" feature – maintenance without disrupting operations

How can maintenance be carried out on the fire alarm system during a company's operations without disrupting them? With SecuriFire's "Secure outputs" feature, which prevents ventilation systems from being switched off, fire doors from being closed, lifts from being taken out of service and conveyor belts and escalators from being stopped. During maintenance, the defined fire incident controls are activated and logged virtually. Only the final switching element is not actuated, so operations are not impacted. The "Secure outputs" feature is displayed as a fault in the fire alarm system to prevent the technician from forgetting to switch the system back on after completing the maintenance.



Lifecycle management: Making sense of the economics



Investment protection with gradual modernisation and phased upgrades

SecuriLine eXtended is compatible with older-generation detectors. This protects your previous investments and allows you to upgrade your system step-by-step for a seamless transition to current and future fire alarm requirements. Continuous, phased modernisation also minimises economic risks arising from the stocking of spare parts and steadily rising maintenance costs.

Backward and forward compatibility

The system is compatible with existing and new generations of detectors. This facilitates solutions that make sense from both an economic as well as a safety perspective.

Efficient upgrading thanks to wizards

The SecuriFire Studio programming tool contains a large number of wizards that help with the upgrading of control panels, units and detectors. They save the technician a lot of time when modernising your system by converting an existing configuration into an equivalent up-to-date configuration in just a few steps – all without the wholesale replacement of existing elements and settings. Gradual modernisation means the system is continuously brought up-to-date with the latest technology. This step-by-step approach keeps costs low and intervention times short. The whole system remains predictable and clear, and the costs can be allocated to an operating budget.

Maximum flexibility throughout the entire service life

The processes relating to your SecuriFire fire alarm system are continuously optimised throughout its service life: from planning and commissioning to ongoing operations, maintenance and modernisation. This is made possible by the easy integration of new product features and the focus on compatibility. The unparalleled forward and backward compatibility combines with modern digital applications to create lasting, unique flexibility.

Complete range of accessories: Components for every application

Detector bases and accessories



Detector testing and tools

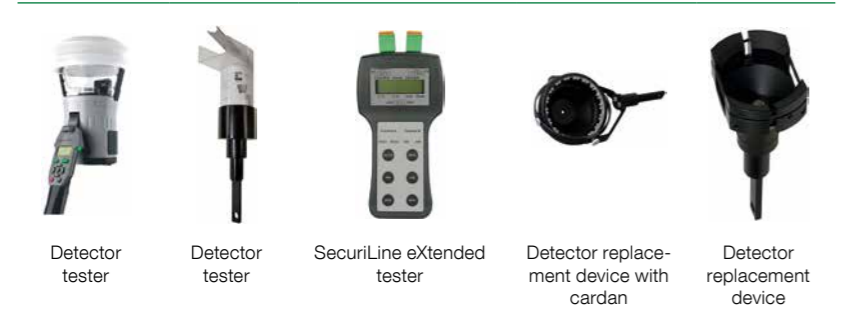

Room indication lamps



Surge protection



Application-specific surge protection devices protect electronic devices from damage caused by transient voltage pulses such as direct lightning strikes.

Power supplies



These external power supplies comply with the EN 54-4 standard and are used for the battery-buffered direct current supply of peripheral devices. Several systems with different configurations are available for ease of installation.

Globally successful: With universally accepted certifications

Global product tests and certifications give SecuriFire fire alarm systems universal market access and worldwide applications.

Maximum service

Digitisation enables numerous new functionalities, which generate significant advantages for our customers – especially when it comes to services. Securiton's fire alarm systems are equipped for the integration of new digital services, which means they will always remain state-of-the-art.

Securiton aims to keep optimising its systems and steadily expand its services. In addition to our technological leadership, we also offer partner-based support from experienced employees: as a result, Securiton is in a position to offer the ideal combination of technical expertise and personal attention.

📍 Securiton maintains a global presence. Our head office is in Switzerland, with subsidiaries or local employees in Mexico, Brazil, Spain, India, Malaysia and China.

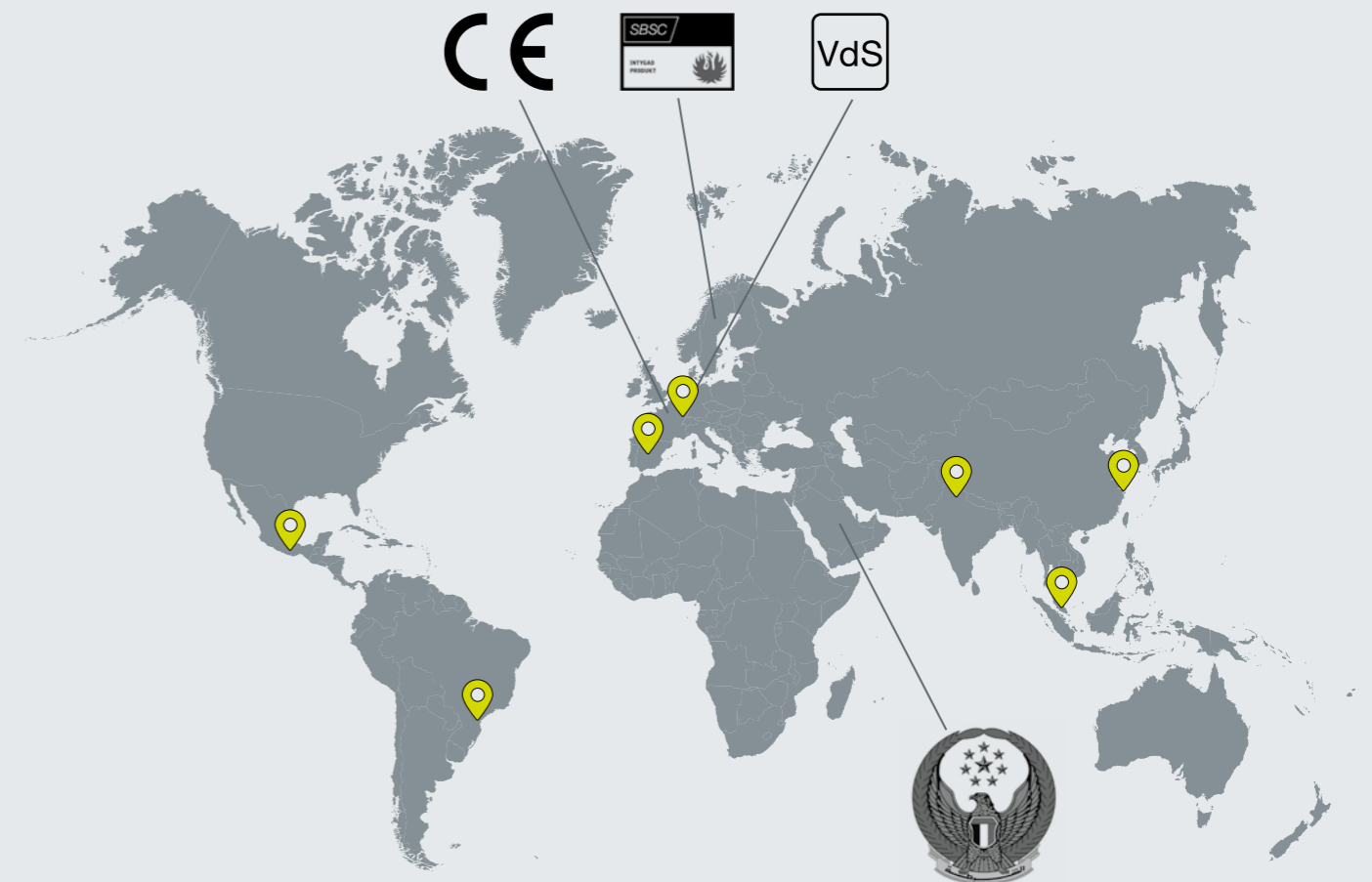

Overview of fire alarm control panels: SecuriFire

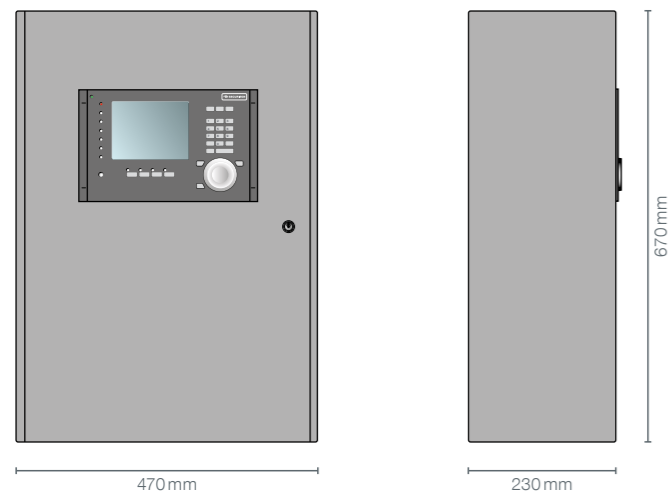

SecuriFire FCP/ECP 3000

B8-SCP30xx technical data

Mains connection	110/230 VAC +10%/-15%
Frequency	47 to 63 Hz
Max. power consumption	280 W
Protection type	IP 30
Ambient temperature	-5 to +50°C
Rel. humidity without condensation	5 to 95%
Weight of basic version without batteries	24 kg

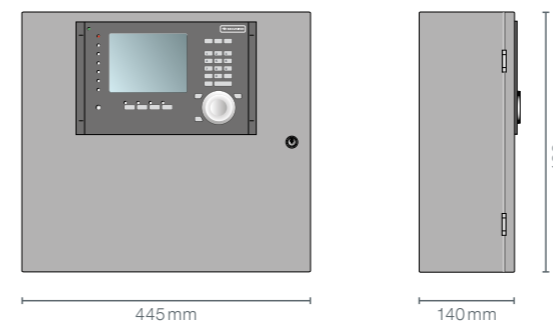

SecuriFire FCP/ECP 2000

B9-SCP20xx technical data

Mains connection	110/230 VAC +10%/-15%
Frequency	47 to 63 Hz
Max. power consumption	160 W
Protection type	IP 30
Ambient temperature	-5 to +50°C
Rel. humidity without condensation	5 to 95%
Weight of basic version without batteries	8 kg

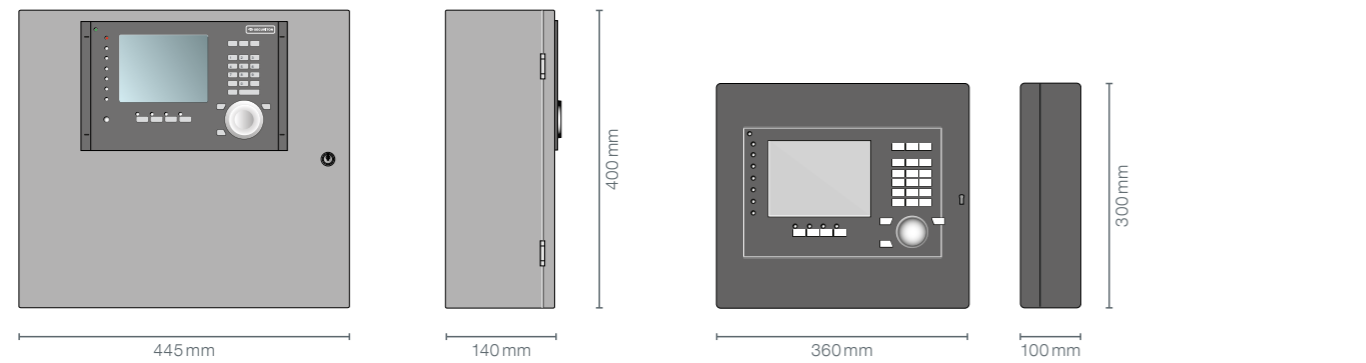

SecuriFire FCP 1000

B9-SCP1020 technical data	
Mains connection	110/230 VAC +10%/–15%
Frequency	47 to 63 Hz
Max. power consumption	160 W
Protection type	IP 30
Ambient temperature	–5 to +50°C
Rel. humidity without condensation	5 to 95%
Weight of basic version without batteries	8 kg

SecuriFire FCP 500

B10-SCP520 technical data	
Mains connection	110/230 VAC +10%/–15%
Frequency	47 to 63 Hz
Max. power consumption	90 W
Protection type	IP 30
Ambient temperature	–5 to +50°C
Rel. humidity without condensation	5 to 95%
Weight of basic version without batteries	2.3 kg

Control panel networking and field bus

SecuriLine eXtended technical data	
Number of addresses	max. 250
Address assignment	Automatic
Addressable loop length	max. 3500 m
SecuriLan technical data	
Bus technology	RS 485, Ethernet, optical fibre
Data transmission	2500 kbit/s
Number of control panels / number of external operating panels	max. 16 / max. 31
Cable (without power supply) Length, RS 485 between 2 devices	Cat 5 UTP RS 485 max. 1200 m
Cable (without power supply), multimode/MTRJ Cable (without power supply), singlemode/LC 2 × 5 Length multimode/singlemode	62.5/125 µm, 50/125 µm 9/125 µm max. 2 km / max. 10 km
SecuriWan technical data	
Bus technology	RS 485, Ethernet, optical fibre
Devices	max. 254 (max. 1024 logical connections)
Data points	max. 100,000
Encryption	AES-128



Securiton AG

Alarm and Security Systems
Alpenstrasse 20, 3052 Zollikofen
www.securiton.com, info@securiton.com

A company of the Swiss Securitas Group
